

Installation and Programming Guide

For Models RD-600, RD-900, RD-1200 (Indoor and Outdoor Models)



Table of Contents

Contents and Specifications	3
Key Features	3
Controller Installation	4
Battery Installation	5
Valve Connection	5
Pump Start Relay or Master Valve Connection	6
Connecting the Power Supply	6
Connecting Earth Ground	7
Buttons and Switches Functions	8
How the Multi-Function Dial Works	9
“Anywhere” Programming	9
What the LCD Display Indicate	10
Watering Considerations	11
Documenting Your Automatic Operation	11
Watering Schedule Chart	12
Fail Safe Mode	13
Setting the Current Time and Day	13
Setting Valve Run Times	13
Setting Program Start Times	13
Setting Program Schedule	14
Activating the Controller	14
How to Check Your Program	14
Semi-Auto Operation	15
Manual Operation	15
Manual Shut-Off	15
Fuse Replacement	15
How to Check for Valve Shorts	16
Troubleshooting the System	16–17
Notes	18
FCC Notice	19

Contents and Specifications

Congratulations. You have purchased the easiest-to-use landscape control system available today. Although it is possible to install and program your Rain Dial® controller with little or no instructions, we strongly recommend that you read this guide first.

Your controller contains:

Outdoor models

- Controller
- 2 keys
- 3 mounting screws
- Instruction guide
- Mounting template

Indoor Models

- Controller
- Plug-in transformer
- 3 mounting screws
- Instruction guide
- Mounting template

Specifications

Transformer voltage input: 120 V a.c., 60 Hz, 0.5 amps (Note: 230 or 240 V a.c., 50 Hz available for international models)

Controller voltage output: 24 V a.c. at 1.0 amp total maximum output; 0.5 amps per station maximum.

Operating temperature range: 32°F to 140°F (0°C to 60°C)

Battery back-up: One 9-volt alkaline battery (supplied by user)

Key Features

- **Modular design** allows:
 - easy access to valve wiring terminals and battery.
 - Simple snap-out removal of module for convenient “anywhere” programming or service without disturbing installation.
 - Easy modular upgrade to as many as 12 stations.
- **Short circuit detection** overrides an electrical malfunction of a valve, identifies it, and allows the other valves to water.
- **Default “fail-safe” program** runs all valves for 10 minutes daily in case of program loss.
- **Rugged, weather resistant, lockable case** comes with 2 keys (outdoor models only).
- **3 Programs** for different watering requirements such as trees, lawns and flower garden.
- **3 start times** for each program, if desired.
- **“Skip day” scheduling** for interval watering from 1 to every 15 days.
- **Fully automatic, semi-automatic or manual operation.**
- **Built-in circuit protection** to protect the controller from power surges.
- **LCD Display** shows current operation, including the time of day.
- **Live programming** allows program to be set or changed at any time, even during watering.
- **Off (or rain) setting** stops all watering cycles without disturbing programs.
- **Battery back-up** saves programs and keeps time during remote programming or power outage.

Controller Installation

Selecting the proper installation site for the controller is essential to safe and reliable operation. The controller should be installed on a vertical wall or other sturdy structure near a grounded power source. For easy operation and better view of the display, install the controller so that the display is at, or slightly below, eye level.

⚠ CAUTION: Do not connect to power until after the valves are connected. Indoor model controllers are not weather resistant and must be installed indoors or in a protected area.

Installing the Indoor Model Controller

- Step 1** - Using the mounting template, mark the location of your Rain Dial in an area protected from weather, such as the garage, and within 5' (1.52M) of a 120 V a.c. outlet (230 or 240 V a.c., 50 Hz for international models). Do not install on the same circuit with a high power user such as a refrigerator or air conditioner.
- Step 2** - Drive a #10 screw into the wall stud, leaving about 1/4" (6.35mm) exposed to slip into the keyhole slot on the back of the controller.
- Step 3** - Open the door to your controller cabinet and swing open the control module by flexing the release tab to the right.
- Step 4** - Use the two provided screw holes to secure the controller with two additional screws. Use wall anchors or toggle bolts if wall is hollow. See **Figure 1**.

Installing the Outdoor Model Controller

- Step 1** - Use the mounting template to locate the two mounting holes. Although you can locate your outdoor controller anywhere, it is best to avoid direct exposure to sprinkler spray. Since this device is "hard wired," keep in mind that you must run electrical cable to it.
- Step 2** - Locate the controller over the area marked with the template, then drive a #10 screw into the wall stud, leaving about 1/4" (6.35mm) exposed to slip into the keyhole slot on the back of the controller.
- Step 3** - Open the door to your controller cabinet and swing open the control module by flexing the release tab to the right.
- Step 4** - Use the two provided screw holes to secure the controller with two additional screws. Use wall anchors, toggle bolts or other appropriate fastener when attaching to other than wall studs. See **Figure 1**.

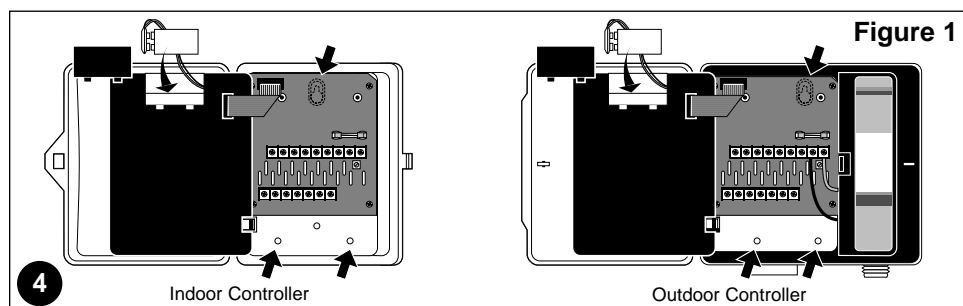

Battery Installation

Installing a standard 9-volt alkaline battery will preserve the controller's time and program in the memory during a power outage.

⚠ CAUTION: Batteries contain hazardous material. Always handle and discard batteries properly in accordance with the battery manufacturer's recommendations.

Step 1 - Open the door to your controller cabinet and swing open the control module by flexing the release tab to the right.

Step 2 - Open the battery compartment located at the top rear of the control module.

Step 3 - Insert a standard 9 volt battery onto the battery clip.

Step 4 - Replace the battery compartment lid and close the control module.
See **Figure 1** on page 4.

Valve Connection

⚠ CAUTION: Before connecting the valves to the controller, make sure that the power supply is unplugged (indoor model) or disconnected (outdoor model).

Step 1 - Open the door to your controller cabinet and swing open the control module by flexing the release tab to the right.

Step 2 - Attach one lead from each valve to a single common wire. Route the common wire through the conduit opening and secure it to the "VC" (valve common) terminal of the terminal board.

Step 3 - Route each remaining valve wire through the provided conduit opening located at the bottom of the controller cabinet. Secure each valve wire to the desired numbered terminal. See **Figure 2**.

⚠ CAUTION: All wiring splices must be waterproofed to prevent short circuit and corrosion. A grease cap or similar waterproofing method can be used to insulate each wire splice connection.

Note: This controller is designed to work with 24 V a.c., 5VA solenoid operated valves. A maximum of two solenoids per terminal may be used, and no more than three solenoids should be on at any time. This includes the master valve and/or pump start, if one is being used. Load requirements should not exceed 1.0 amp maximum current draw.

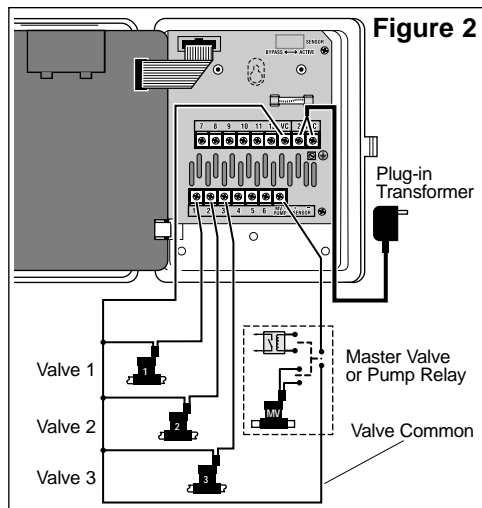

Pump Start Relay or Master Valve Connection

When a pump start relay or a master valve is to be operated by the controller, a compatible device must be used. The master valve must be equipped with a 24 V a.c., 0.2 amps, 5VA solenoid. If using a pump relay, it should have a nominal coil voltage of 24 V a.c. at 0.25 amps maximum. The controller should not be installed within 5' (1.52m) of a pump or pool equipment.

Step 1 - Route the relay or the master valve wires to the controller using the same conduit opening used for the valves. See **Figure 2** on page 5.

Step 2 - Connect one wire to "MV/PUMP" terminal and the other to "VC" terminal.

⚠ CAUTION: If you are using a pump start circuit, the fail-safe program will activate the pump for each valve for 10 minutes on Program A. If all valves are not being used, the pump will run against a "dead head" on each unused valve. This can damage the pump. To avoid this, connect a jumper wire from the unused valve terminal to a valve terminal that is in use.

Connecting the Power Supply

Power Connection for Indoor Model

After you have installed the controller securely and made all necessary valve connections, route the two leads from the plug-in transformer through the bottom conduit opening and connect to the "24 VAC" terminals. Close the control module and plug the transformer into a 120 V a.c., 60 Hz power source (230 or 240 V a.c., 50 Hz power source for international models). The display should flash "12:00 PM".

Power Connection for Outdoor Model

Outdoor controllers have a built-in transformer which must be connected directly to a grounded, 120 V a.c. power source (230 or 240 V a.c., 50 Hz for international models).



Warning: All electrical components must meet applicable national and local electrical codes including installation by qualified personnel.

On outdoor models, these codes may require an external junction box mounted on the transformer 1/2" NPT nipple and a means in the fixed wiring of disconnecting AC power having a contact separation of at least 0.120" (3mm) in the line and neutral poles.

Ensure the AC power source is OFF prior to connecting to the controller.

The wire used for connection to the controller must have insulation rated at 105° C minimum.

(Continued to the next page)

⚠ CAUTION: Do not connect the controller to one phase of a 3-phase power system used by a pump or other electrical equipment.

- Step 1 -** Turn off the installation power source at the associated circuit breaker. Verify that power has been turned off by using an appropriate AC voltage meter.
- Step 2 -** Install the conduit and associated fittings.
- Step 3 -** Connect power and ground wires per electrical codes. See **Figure 3**.
- Step 4 -** Turn the power source on and check for proper controller operation. If the controller is not operating, disconnect the power source and check for a short-circuit or improper wiring in the system.

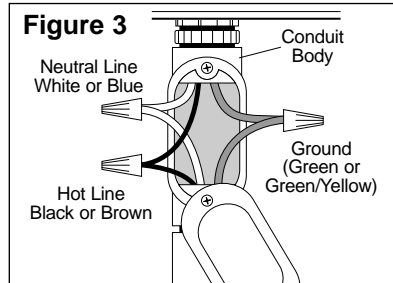

Connecting Earth Ground

The built-in circuit protection in all Rain Dial controllers must have an earth ground path to help protect the controller from power surges. A power surge is a sudden rise in voltage on the main power line. A lightning strike on the power grid is the most common cause of power surges and can be damaging to the controller. The built-in circuit protection reduces the potential for surge damage by shunting the voltage to earth ground. Therefore, an important step of the installation process is to properly connect the controller to an earth ground source, especially if the controller is located in a lightning-prone area.

- Step 1 -** Route a 12-16 gauge (2.0–1.0mm²) solid copper wire in the shortest and most direct path without sharp bends from the earth ground (⊕) lug, located on the terminal board, to an earth ground source such as a metal water pipe or copper-clad ground rod.
- Step 2 -** Clamp the end of the ground wire securely to the pipe or ground rod. Make sure the wire contact area is free of dirt and corrosion. See **Figure 4**.

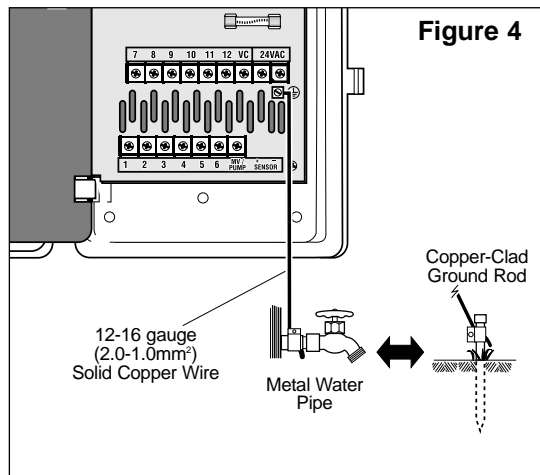

Buttons and Switches Functions

Program Switch - Used to select from the three different programs (**A**, **B** and **C**) when setting program. It is also used to select which pre-set program (**A**, **B** or **C**) to run for semi-automatic operation.

Function Switch - Used to stop a program's watering cycle and any valves that are currently running if positioned to **OFF** or **STOP**. In this mode, all programs are retained and watering will not resume until the switch is returned to **RUN** or **Manual**. To set or change the controller's programs, position the **Function Switch** to **Set Programs**. Place the switch into the **Run** or **Manual** position to operate manually or activate the controller's automatic watering cycles.

Semi-Auto Start Button - Used in conjunction with the **Program Switch**. When depressed, it immediately starts the program selected at the **Program Switch**, (**A**, **B** or **C**), regardless of its automatic start time.

Manual Start Button - Used in conjunction with the **Multi-Function Dial** and **+/- Buttons**. When depressed, it operates the selected valve indicated by the **Multi-Function Dial** for the duration entered by the user.

Multi-Function Dial - Used to set, check or change program information in conjunction with the **+/- Buttons**. After using the dial, always return it to the **Current Time** position.

+/- Buttons - Used in conjunction with **Multi-Function Dial** to set or change program information. It is usually used to advance or decrease numbers or toggle from **ON** or **OFF** selection. Single finger taps to either button will advance or reduce data one character at a time. Holding either button down will advance data at a rate of 12 characters per seconds.

LCD Display - Shows the current operation.

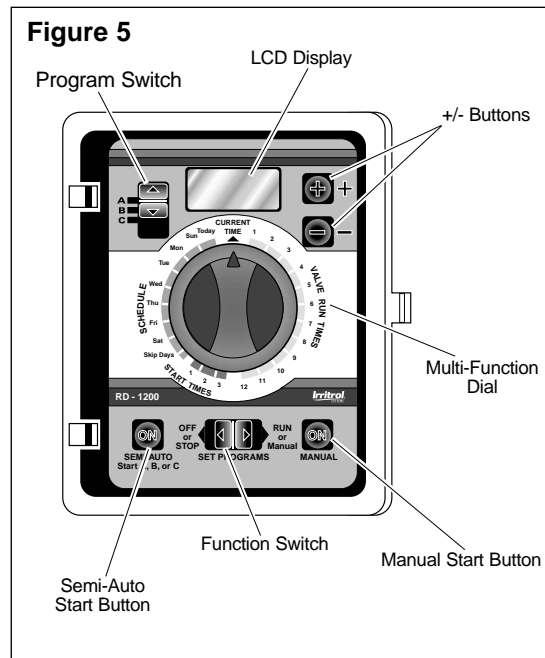

How the Multi-Function Dial Works

“Valve Run Time” Settings - These settings control how long each valve will water. The valve numbers on the **Multi-Function Dial** corresponds to the numbers on the controller’s terminal module. The valves run sequentially one at a time. Each valve can be set to run from 1 minute to 5.9 hours.

“Start Times” Settings - Up to three different start times (time of day) can be selected for each program. Multiple start times are especially useful for newly seeded lawns.

Note: If a running program overlaps to the next day, the timer will finish the current program before continuing to the next day schedules. Programs postponed to run after midnight will be ignored.

“Schedule” Day Settings - This setting designates the watering interval for your program. You can choose to water at any particular day of the week (for example, watering every monday and thursday), or use the pre-programmed Skip Days option (e.g. water every 4 days, water every 3 days, etc.).

“Today” Settings - This setting is used to designate what day **Today** is. Scroll through either **MO–SU** option or numerical option using the **+/-** buttons, depending on your **Schedule** setting.

“Anywhere” Programming

The Rain Dial control module can be easily removed for complete programming or service in a more convenient location. The module’s battery power will keep the program stored until the module is re-electrified.

- Step 1** - To remove the module, swing open the control module by flexing the release tab to the right.
- Step 2** - Grasp the ribbon cable assembly closest to the connector and pull it out from the socket. See **Figure 6**.
- Step 3** - Carefully unsnap the module from the two hinge post.
- Step 4** - After programming or servicing, reinstall the control module by reversing the steps above.

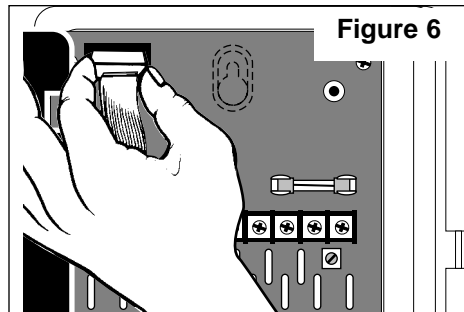

What the LCD Display Indicate

Information Displayed When Programming

The **LCD** will display the following data with the **Function Switch** in the **SET PROGRAMS** position, in conjunction with the following dial settings.

Valve Run Times - Shows minutes (e.g. 15 MIN) or hour (e.g. 1.5 HOUR). Also displays **OFF** for unused valves.

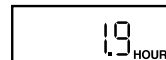

Start Times - Displays time in **AM**, **PM** or **OFF** for unused start times.



Skip Days - Shows days numbered 1–15, or **OFF**. The words, **ONCE EVERY** appear to the left.



Schedule - Displays **ON** or **OFF**. If **Skip Days** has been set, three dashes (–) and the words **SKIP MODE** will be displayed for each of the seven daily settings.

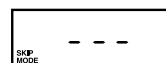

Today - Displays seven individual days for a weekly schedule, or displays day interval numbers (1–15) for a **Skip Days** schedule.

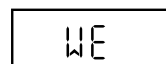

Information Displayed During Operation

With the **Function Switch** in the **RUN** position and the dial set to **CURRENT TIME**, the currently operating valve number will be displayed.

Automatic Mode with No Program ON - With the **Function Switch** in the **RUN** position, the current time with a flashing colon (:) is displayed. If the entire display is flashing, the controller has just been plugged in or there has been a power outage. If the colon is not flashing, the controller is using battery power.

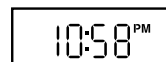

Automatic or Semi-Auto Mode With Program ON - Displays the current time. Turn the dial to an active valve and the display will show the valve number, the program (**A**, **B** or **C**) and the time remaining for that valve to run. If you turn the dial to a valve that is not currently on, the display shows **OFF** (even though that valve may have a programmed run time).

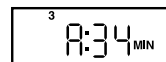

Manual Mode - With the dial pointing to the appropriate valve, the display shows the valve's number, an **M** (for manual), and the time remaining for the valve to run.

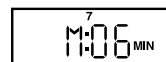

Short / Malfunction Detection - A flashing **OFF** indicates that the dial is pointing to a valve that has a short or other electrical malfunction.

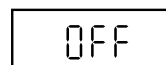

Note: After a power outage or when the controller is energized, the display will flash 12:00 PM (or the current time if it was a short outage). Stop the flashing by pressing either of the **+/- Buttons**.

Watering Considerations

Plants, soil and climatological conditions vary from region to region. Consult your local nursery for the watering schedule best suited to your particular requirements. As a general rule, the best time to water is early morning because evaporation, wind drift and temperature are minimal. Evening watering may promote mildew and fungus growth.

Documenting Your Automatic Operation

Use the chart on this page to note your valve locations, their corresponding numbers and their auto operation.

PROGRAMMING WATERING SCHEDULE						
WATERING TIMES						
Valve Station	A Program	B Program	C Program	Valve / Station Description		
1						
2						
3						
4						
5						
6						
7						
8						
9						
10						
11						
12						
				Start Times		
				1st	2nd	3rd
				Watering Days		

Watering Schedule Chart

PROGRAMMING WATERING SCHEDULE						
WATERING TIMES						
Valve Station	A Program	B Program	C Program	Valve / Station Description		
1						
2						
3						
4						
5						
6						
7						
8						
9						
10						
11						
12						
				Start Times		
				1st	2nd	3rd
						Watering Days

Fail Safe Mode

If the battery fails during a power interruption, your program will be lost. When power is restored, the Rain Dial controller will automatically default to its fail-safe mode. Upon restoration of power, the fail-safe mode will default to Sunday, 12:00 p.m. and the clock resumes from that point. Unless reprogrammed, the controller will energize each valve for 10 minutes, beginning at 7:00 a.m. (controller clock time) everyday. This feature is designed to protect lawns and plants from dying out when a power outage occur while you are away from home for a prolonged period of time.

Note: In freeze prone areas, disconnect the controller while you are away to prevent activation of the fail-safe program.

Setting the Current Time and Day

- Step 1 -** Set the **Multi-Function Dial** to **CURRENT TIME**.
- Step 2 -** Position the **Function Switch** to **SET PROGRAMS**.
- Step 3 -** Use the **+/- Buttons** to set the current time.
- Step 4 -** Turn the **Multi-Function Dial** to **TODAY**.
- Step 5 -** Use the **+/- Buttons** to select the current day from the **MO-SU** options. If using the **Skip Days** option, select a numerical number to designate what day today should be according to your planned schedule. For example, if you want to water every 8 days and you watered 4 days ago, you would enter the number 4 in the **Today** setting so that in 4 more days, watering cycle will begin.
- Step 6 -** Return the **Multi-Function Dial** to the **CURRENT TIME** position and the **Function Switch** to the **RUN** position when finished.

Setting Valve Run Times

- Step 1 -** Set **Program Switch** to **A**.
- Step 2 -** Move **Function Switch** to **SET PROGRAMS**.
- Step 3 -** Turn the **Multi-Function Dial** to valve number 1.
- Step 4 -** Use the **+/- Buttons** to enter how long the valve will water during program **A**.
- Step 5 -** Repeat Sept 3 for valve number 2, valve number 3 and so on. Set unused valves to **OFF**.

Repeat the above steps if you wish to use programs **B** and **C**.

Setting Program Start Times

- Step 1 -** Set **Program Switch** to the desired program (**A**, **B**, or **C**).
- Step 2 -** Move **Function Switch** to **SET PROGRAMS**.
- Step 3 -** Turn the **Multi-Function Dial** to the **START TIMES** number 1.
- Step 4 -** Use the **+/- Buttons** to enter the time when you want the program to start.
- Step 5 -** If you want the selected program to water more than once a day, turn dial to **START TIME** number 2 and repeat step 3. To turn off a start time, press the **+** button until **OFF** is displayed. **OFF** is displayed after 11:59 PM.

Setting Program Schedule

Before setting the schedule, decide whether you want to use the controller's daily schedule option or the interval **SKIP DAYS** option. The daily option gives you the option of selecting particular days to water in no particular order (for example, water every Monday, Wednesday and Saturday).

Daily Schedule Option

Step 1 - Position the **Program Switch** to **A**.

Step 2 - Move **Function Switch** to **SET PROGRAMS**.

Step 3 - Position the **Multi-Function Dial** to **Sun**.

Step 4 - Use the **+/-** button to select between **ON** or **OFF**.

Step 5 - Repeat this procedure to each succeeding day of the week.

Repeat the above steps if you wish to use programs **B** and **C**.

Note: When using this schedule option, make sure that the **Skip Days** is set to **OFF**.

Skip Days Schedule Option

Step 1 - Position the **Program Switch** to **A**.

Step 2 - Move **Function Switch** to **SET PROGRAMS**.

Step 3 - Position the **Multi-Function Dial** to **Skip Days**.

Step 4 - Use the **+/-** button to set the desired daily interval (for example, 3 for once every third day).

Step 5 - Turn the **Multi-Function Dial** to **Today** and use the **+/- Buttons** to set which day in the cycle today should be.

Repeat the above steps if you wish to use programs **B** and **C**.

Activating the Controller

Moving the **Function Switch** to the **RUN** setting will activate the program you have just entered.

Note: While the **Function Switch** is in the **RUN** position, the **Program Switch** will have no effect. The controller will run all three programs at their designated start times even if the **Program Switch** is positioned at program **A**, **B** or **C**.

How to Check Your Program

Step 1 - Move the **Function Switch** to **OFF**

Step 2 - Move the **Program Switch** to the program you wish to check

Step 3 - Turn the dial to any of the parameters you want to check.

Note: With the **Function Switch** in the **OFF** position, you can check, but you can not change the parameters in the program.

Semi-Auto Operation

Semi-Auto operation runs an entire program (A, B or C) whenever you want a supplemental watering.

Step 1 - Make sure the **Function Switch** is in the RUN position and the **Multi-Function Dial** is pointing to the **CURRENT TIME** position.

Step 2 - Use the **Program Switch** to select the program (A, B or C) you want to run.

Step 3 - Press the **SEMI-AUTO Start Button** to start the cycle. The controller will resume its regular schedule when the cycle is finished.

To cancel the **SEMI-AUTO** operation, move the function switch to **OFF** or **STOP**, then back to **RUN** or **MANUAL**.

Manual Operation

Manual Operation runs a single valve for the duration you designate.

Step 1 - Make sure the **Function Switch** is in the **RUN** position.

Step 2 - Position the dial to the valve number (1–12) you want to run.

Step 3 - Use the **+/- Buttons** to specify the amount of time you want the valve to water.

Step 4 - Press the **Manual Start Button**.

Step 5 - Return the **Multi-Function Dial** to **CURRENT TIME** position. Move the Function Switch to **OFF** or **STOP** position to cancel manual operation.

Note: If the **Multi-Function Dial** is left at the valve number position, the display will show an **M** (for manual), the valve number, and the time remaining for that valve to run. When the manual cycle is complete, the controller will resume its regular schedule.

Manual Shut-Off

Step 1 - Make sure the **Multi-Function Dial** points to the **CURRENT TIME** position.

Step 2 - Move the **Function Switch** to **OFF**.

The scheduled watering cycles will resume when the **Function Switch** is returned to **RUN** position.

Fuse Replacement

Step 1 - Disconnect the power source to the controller.

Step 2 - Carefully remove the fuse from the fuse clips.

Step 3 - Install a new 2.0 amps Slo-Blo fuse, ensuring that it is securely seated at both ends of the fuse clip. See **Figure 6**.

Step 4 - Restore power to the controller.

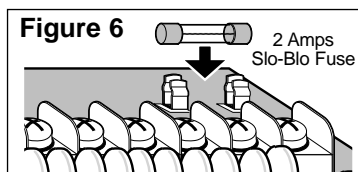

WARNING: The fuse protects the transformer from overload due to a short circuit condition. For continued protection against risk of fire, replace only with the same type and rating of fuse. Ensure power to the controller is off prior to removing or installing fuse.

How to Check for Valve Shorts

The Rain Dial controllers are uniquely able to detect and identify malfunctioning valves caused by electrical shorts in the wiring. Use your controller to check any or all valves for shorts.

Step 1 - Make sure the **Function Switch** is set to **RUN**.

Step 2 - Turn the **Multi-Function Dial** to the valve number you want to check.

Step 3 - Use the **+/- Button** to enter a run time.

Step 4 - Press the **Manual Button**.

If the display flashes **OFF**, that particular valve has an electrical short or other problem. The solenoid and field wiring should be inspected.

⚠ CAUTION: Do not test valves by touching wire ends to the terminal screws. Serious damage to the controller may result.

Troubleshooting the System

Problem	Possible Cause	Correction
Some valves do not operate.	Defective solenoid Loose wire connection.	Test and replace solenoid. Secure wire connections. Check for connection continuity.
No valves operate.	Function Switch in OFF or STOP position. Solenoid defective. Loose wire connection. Day set to OFF . Skip Days incorrectly set. Start Times set to OFF .	Set switch to RUN or MANUAL position. Test and replace solenoid. Secure wire connections. Check for connection continuity. Check current day in display. Set dial to correct day and check setting. Check and reprogram Skip Days schedule option. Reprogram Start Times .

Troubleshooting the System

Problem	Possible Cause	Correction
Watering at wrong times.	CURRENT TIME of day incorrectly set.	Check and reset CURRENT TIME .
Blank display.	No power.	Check circuit breaker panel. Check wiring connections. Check transformer. Check controller terminal board fuse.
Program won't display.	Wrong function setting. Controller is in watering cycle.	Function Switch must be in RUN or MANUAL setting. Check or change program with Function Switch in Set Programs .
Incorrect display (after a power outage or after being unplugged).	Battery is weak or missing.	Remove AC power and battery for 1 minute. Replace battery, restore power and reprogram.
Waters on wrong days.	Weekly or Skip Days schedule are incorrectly set.	Reprogram Program Schedule (Page 11).
Current time is wrong and flashing.	Power outage occurred with no battery or weak battery in controller.	Replace battery and reprogram controller.
Display is flashing.	Excessive load. Shorted solenoid or field wiring.	Check max. ratings. (See the bottom note on page 5.) Check solenoids and wiring.
Valve won't turn off (function switch off).	Mechanical override (Manual bleed is on).	Turn solenoid on top of valve fully clockwise.

FCC Notice

Domestic: This equipment has been tested and found to comply with the limits for a Class B digital device, pursuant to Part 15 of the FCC Rules. These limits are designed to provide reasonable protection against harmful interference in a residential installation. This equipment generates, uses and can radiate radio frequency energy and, if not installed and used in accordance with the instructions, may cause harmful interference to radio communications. However, there is no guarantee that interference will not occur in a particular installation. If this equipment does harmful interference to radio or television reception, which can be determined by turning the equipment off and on, the user is encouraged to try to correct the interference by one or more of the following measures:

1. Reorient or relocate the receiving antenna.
2. Increase the separation between the equipment and receiver.
3. Connect the equipment into an outlet on a circuit different from that to which the receiver is connected.
4. Consult the dealer or an experienced radio/TV technician for help.

The user may find the following booklet prepared by the Federal Communications Commission helpful:

"How To Identify and Resolve Radio-TV Interference Problems". This booklet is available from the U.S. Government Printing Office, Washington, DC 20402. Stock No. 004-000-00345-4.

International: This is a CISPR 22 Class B product.

**Irritrol Systems offers complete lines of professional
irrigation products for commercial and
residential applications:**

Controller and Controller Accessories

Valves and Valve Accessories

Sprinklers, Nozzles and Sprayheads



U.S.A.:
P.O. Box 489
Riverside, California 92502
Tel: (909) 785-3623
(800) 634-8873

Australia:
Irritrol Systems PTY Ltd.
53 Howards Road
Beverley SA 5009
Tel: (08) 8300 3633

Europa:
Irritrol Systems Europe s.p.a.
Via dell'Artigianato, 1/3-Loc Prato della Corta
00065 Fiano Romano (Roma), Italia
Tel: (39) 0765 455201